



- Model 989 — Recessed **Bradex**[®]
- Model 989-11 — Surface Mounted

- Standard Series — Satin Finish
- Accommodates BD Brand Sharps Collector, part number 305443 (supplied by others)

Product Materials

FLANGE: 22 gauge stainless steel with exposed surfaces in architectural satin finish. One-piece seamless construction, 1" wide with 1/4" return.

CABINET: heavy gauge stainless steel. All welded construction.

DOOR: 22 gauge stainless steel with exposed surfaces in architectural satin finish. Heavy-duty stainless steel piano hinge.

Capacity

BD Brand, Needle Disposal 5.4 qt

Operation

Needle disposal unit installed/removed by locked hinged door. Needle disposal unit supplied by others.

- Door must open down 180° for install/removal of needle disposal.

Installation

Verify all rough-in dimensions prior to installation. Requires rough wall opening 12"W x 17 3/8"H x 5"D. Secure to framing with mounting screws (not included) at holes provided. Shim at screw points as required.

Guide Specification

Recessed needle disposal shall be fabricated of stainless steel with exposed surfaces in satin finish. Door secured by piano hinge. Removable needle disposal with tumbler lock.

Overall dimensions: 13 3/4"W x 19 1/8"H x 5 1/8"D.

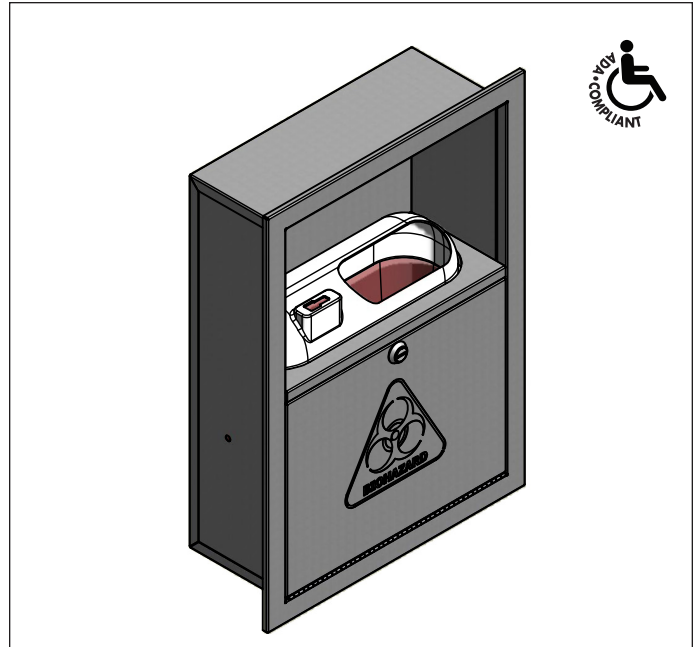

ADA Compliant

- Consult local and national accessibility codes for proper installation guidelines.
- Conformity and compliance to local and national codes is the responsibility of the installer.

Orders composed of products indicated as **Bradex**[®] will be available to ship in three days after receipt of order at the factory. There is no pricing penalty for this service from Bradley.



Dimensions (mm)

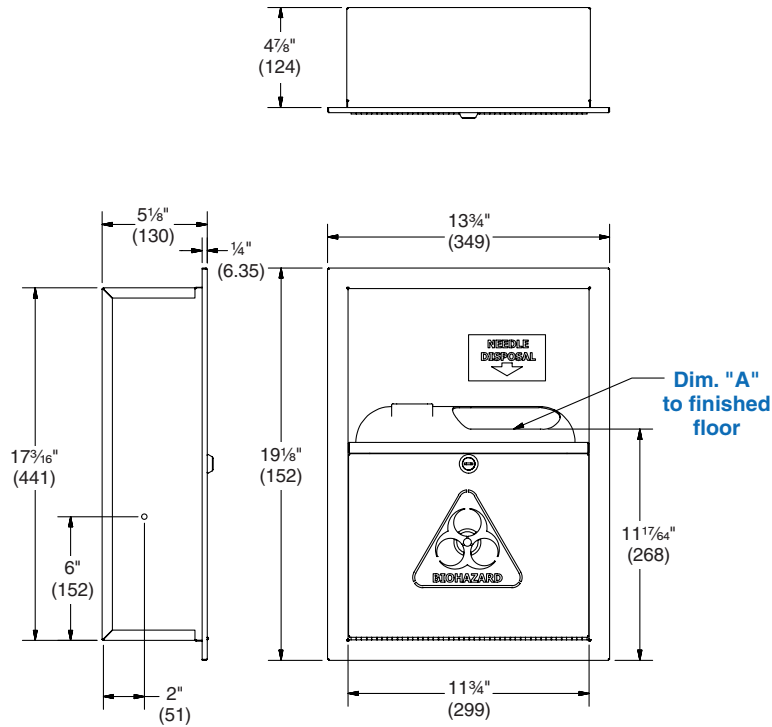

Dim. "A" Key Surface:	For Dim. "A"	Top of Rough Wall Opening	Bottom of Rough Wall Opening
Top of door to finished floor	48" (1219)	55" (1397)	37 7/8" (956)
Rough wall opening:			
Recessed:	12" (305) Wide x 17 3/8" (441) High x 5" (127) Deep		

Orders composed of products indicated as **Bradex**® will be available to ship in three days after receipt of order at the factory. There is no pricing penalty for this service from Bradley.